

SECTION A-A

SECTION B-B

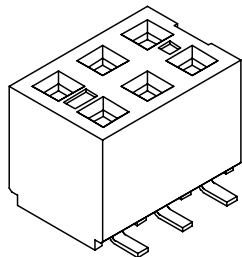

NOTES:

1. HOUSING MATERIAL:
LCP, GLASS FILLED, UL 94V-0
COLOUR BLACK.
2. TERMINAL MATERIAL:
PHOSPHOR BRONZE
3. SEE APPROPRIATE SHEET FOR CIRCUIT SIZE,
PART NUMBERS AND OVERALL DIMENSIONS.
4. FOR ILLUSTRATION, 6 CKT ASSY SHOWN.
5. REFER TO PRODUCT SPEC PS-79107.
PS-79107 DOES NOT APPLY TO PLATING NO. 608.
6. TUBE PACKAGING PER PK-70873-0217 OR
TAPE PACKAGING PER PK-70873-0259
7. SEE SHT 4 FOR PEG OPTION ASSEMBLIES.
8. CKT LOCATIONS ARE NUMBERED FROM LEFT TO
RIGHT WHEN VIEWING ASSY FROM TOP WITH
THE GATE RECESS ON THE RIGHT AS SHOWN.
9. SEE SHT 7,8 & 9 FOR VOIDED CIRCUIT PART NUMBERS.

PLATING OPTION:

1. 30u" (0.75um) MIN. GOLD PLATE IN SELECTED AREA AND
75u" (1.88um) MIN. TIN/LEAD PLATE IN SELECTED AREA OVER
50u" (1.25um) MIN. NICKEL OVERALL.
2. 15u" (0.38um) MIN. GOLD PLATE IN SELECTED AREA AND
75u" (1.88um) MIN. TIN/LEAD PLATE IN SELECTED AREA OVER
50u" (1.25um) MIN. NICKEL OVERALL.
3. 5u" (0.13um) MIN. GOLD PLATE IN SELECTED AREA AND
75u" (1.88um) MIN. TIN/LEAD PLATE IN SELECTED AREA OVER
50u" (1.25um) MIN. NICKEL OVERALL.
4. 30u" (0.75um) MIN. GOLD PLATE IN SELECTED AREA AND
75u" (1.88um) MIN. TIN PLATE IN SELECTED AREA OVER
50u" (1.25um) MIN. NICKEL OVERALL.
5. 15u" (0.38um) MIN. GOLD PLATE IN SELECTED AREA AND
75u" (1.88um) MIN. TIN PLATE IN SELECTED AREA OVER
50u" (1.25um) MIN. NICKEL OVERALL.
6. 5u" (0.13um) MIN. GOLD PLATE IN SELECTED AREA AND
75u" (1.88um) MIN. TIN PLATE IN SELECTED AREA OVER
50u" (1.25um) MIN. NICKEL OVERALL.

UPDATE REVISION EC NO: S2005-0714 DRWN:KSEE CHKD:BLW APPR:PTLIM 2005/10/19 2005/10/19 2005/11/06	QUALITY SYMBOLS ▽=0 ▽=0	GENERAL TOLERANCES (UNLESS SPECIFIED)		DIMENSION STYLE		SCALE	DESIGN UNITS	THIRD ANGLE PROJECTION		
				IN/MM		NTS	INCH			
				mm	INCH	DRAWN BY		DATE		SALES DRAWING 2MM DUAL ROW VERTICAL RECEPTACLE, SMT MOLEX INCORPORATED
				4 PLACES ± --- ± ---	AAB	1989/05/15	TITLED			
		3 PLACES ± --- ± .010	CHECKED BY		DATE					
		2 PLACES ± 0.25 ± .015	MJM		1989/05/15					
		1 PLACE ± 0.38 ± ---	APPROVED BY		DATE					
		ANGULAR ± 3 °	WAZ		1989/05/15					
		DRAFT WHERE APPLICABLE MUST REMAIN WITHIN DIMENSIONS		MATERIAL NO.		DOCUMENT NO.		SHEET NO.		
				SEE TABLE		SDA-79109-***		1 OF 9		
				THIS DRAWING CONTAINS INFORMATION THAT IS PROPRIETARY TO MOLEX INCORPORATED AND SHOULD NOT BE USED WITHOUT WRITTEN PERMISSION						

TIN/LEAD OPTION

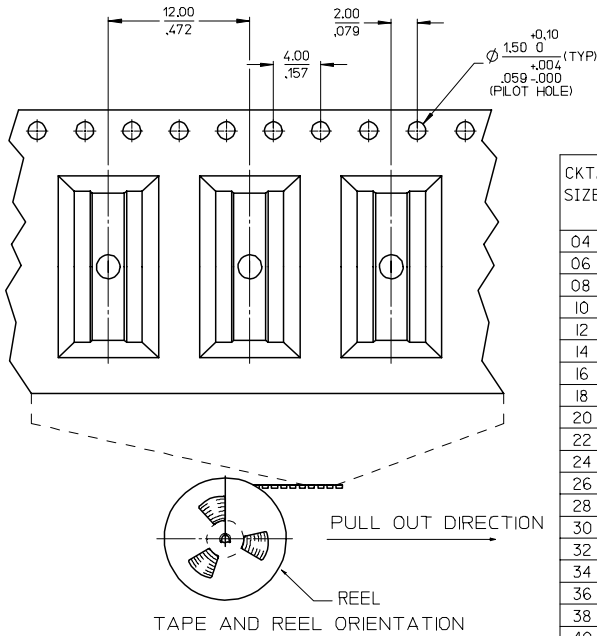

CKT. SIZE	DIM. "A"		DIM. "B"		DIM. "D"		PLATING OPTION 2		PLATING OPTION 1		PLATING OPTION 3	
	INCH	MM	INCH	MM	INCH	MM	ITEM NO. TUBE PACKED (WITHOUT CAP)	ITEM NO. TAPE PACKED (WITH CAP)	ITEM NO. TUBE PACKED (WITHOUT CAP)	ITEM NO. TAPE PACKED (WITH CAP)	ITEM NO. TUBE PACKED (WITHOUT CAP)	ITEM NO. TAPE PACKED (WITH CAP)
04	.079	(2.00)	.165	(4.19)	.183	(4.65)	79109-0001	79109-8001	79109-0051	79109-8051	X	79109-0101
06	.157	(4.00)	.244	(6.19)	.183	(4.65)	79109-0002	79109-8002	79109-0052	79109-8052	X	79109-0102
08	.236	(6.00)	.322	(8.19)	.183	(4.65)	79109-0003	79109-8003	79109-0053	79109-8053	X	79109-0103
10	.315	(8.00)	.401	(10.19)	.183	(4.65)	79109-0004	79109-8004	79109-0054	79109-8054	X	79109-0104
12	.394	(10.00)	.480	(12.19)	.183	(4.65)	79109-0005	79109-8005	79109-0055	79109-8055	X	79109-0105
14	.472	(12.00)	.559	(14.19)	.183	(4.65)	79109-0006	79109-8006	79109-0056	79109-8056	X	79109-0106
16	.551	(14.00)	.637	(16.19)	.183	(4.65)	79109-0007	79109-8007	79109-0057	79109-8057	X	79109-0107
18	.630	(16.00)	.716	(18.19)	.183	(4.65)	79109-0008	79109-8008	79109-0058	79109-8058	X	79109-0108
20	.709	(18.00)	.795	(20.19)	.183	(4.65)	79109-0009	79109-8009	79109-0059	79109-8059	X	79109-0109
22	.787	(20.00)	.874	(22.19)	.183	(4.65)	79109-0010	79109-8010	79109-0060	79109-8060	X	79109-0110
24	.866	(22.00)	.952	(24.19)	.183	(4.65)	79109-0011	79109-8011	79109-0061	79109-8061	X	79109-0111
26	.945	(24.00)	1.031	(26.19)	.183	(4.65)	79109-0012	79109-8012	79109-0062	79109-8062	X	79109-0112
28	1.024	(26.00)	1.110	(28.19)	.183	(4.65)	79109-0013	79109-8013	79109-0063	79109-8063	X	79109-0113
30	1.102	(28.00)	1.188	(30.19)	.183	(4.65)	79109-0014	79109-8014	79109-0064	79109-8064	X	79109-0114
32	1.181	(30.00)	1.267	(32.19)	.183	(4.65)	79109-0015	79109-8015	79109-0065	79109-8065	X	79109-0115
34	1.260	(32.00)	1.346	(34.19)	.183	(4.65)	79109-0016	79109-8016	79109-0066	79109-8066	X	79109-0116
36	1.338	(34.00)	1.425	(36.19)	.183	(4.65)	79109-0017	79109-8017	79109-0067	79109-8067	X	79109-0117
38	1.417	(36.00)	1.504	(38.19)	.183	(4.65)	79109-0018	79109-8018	79109-0068	79109-8068	X	79109-0118
40	1.496	(38.00)	1.582	(40.19)	.183	(4.65)	79109-0019	79109-8019	79109-0069	79109-8069	X	79109-0119
42	1.575	(40.00)	1.661	(42.19)	.183	(4.65)	79109-0020	79109-8020	79109-0070	79109-8070	X	79109-0120
44	1.654	(42.00)	1.740	(44.19)	.183	(4.65)	79109-0021	79109-8021	79109-0071	79109-8071	X	79109-0121
46	1.732	(44.00)	1.818	(46.19)	.183	(4.65)	79109-0022	79109-8022	79109-0072	79109-8072	X	79109-0122
48	1.811	(46.00)	1.897	(48.19)	.183	(4.65)	79109-0023	79109-8023	79109-0073	79109-8073	X	79109-0123
50	1.890	(48.00)	1.976	(50.19)	.183	(4.65)	79109-0024	79109-8024	79109-0074	79109-8074	X	79109-0124

NOTES:

1. LEADER AND TRAILER TAPE

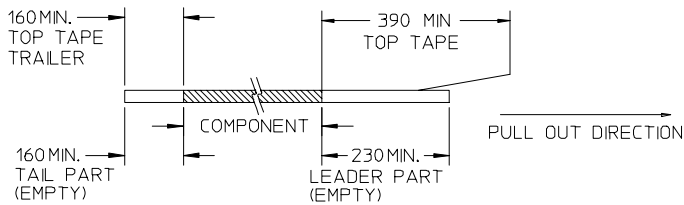

2. PEELING OFF FORCE OF THE TOP TAPE: 20-80gf. (PEELING DIRECTION AS SHOWN IN FOLLOWING FIGURE)

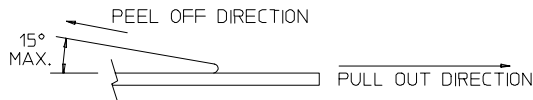

3. PACKAGING STANDARD IS AS PER EIA-481.

4. TAPE & REEL QUANTITY = 500 PCS/REEL

*X INDICATES TOOLING NOT AVAILABLE

SPECIAL PACKAGING (TAPE PACKED WITHOUT CAP)

CKT. SIZE	DIM. "A"		DIM. "B"		DIM. "D"		ITEM NO.	PLATING OPTION SEE SHEET 1
	INCH	MM	INCH	MM	INCH	MM		
06	.157	(4.00)	.244	(6.19)	.183	(4.65)	79109-9000	2
20	.709	(18.00)	.795	(20.19)	.183	(4.65)	79109-9001	2
50	1.890	(48.00)	1.976	(50.19)	.183	(4.65)	79109-9002	2
34	1.260	(32.00)	1.346	(34.19)	.183	(4.65)	79109-9003	2

ADD LEADER & TRAILER EC NO: S2005-0714 DRWN:KSEE CHKD:BLHOW APPR:PTLIM 2005/10/19 2005/10/19 2005/11/06	QUALITY SYMBOLS ▽=0 ▽=0	GENERAL TOLERANCES (UNLESS SPECIFIED) mm INCH 4 PLACES ± --- ± --- 3 PLACES ± --- ± .010 2 PLACES ± 0.25 ± .015 1 PLACE ± 0.38 ± --- ANGULAR ± 3 °	DIMENSION STYLE IN/MM DRAWN BY DATE AAB 1989/05/15 CHECKED BY DATE MJM 1989/05/15 APPROVED BY DATE WAZ 1989/05/15	SCALE NTS DESIGN UNITS INCH THIRD ANGLE PROJECTION	SALES DRAWING 2MM DUAL ROW VERTICAL RECEPTACLE, SMT MOLEX INCORPORATED
		DRAFT WHERE APPLICABLE MUST REMAIN WITHIN DIMENSIONS	MATERIAL NO. SEE TABLE	DOCUMENT NO. SDA-79109-***	SHEET NO. 2 OF 9
		THIS DRAWING CONTAINS INFORMATION THAT IS PROPRIETARY TO MOLEX INCORPORATED AND SHOULD NOT BE USED WITHOUT WRITTEN PERMISSION			
		SIZE A3			

TIN OPTION

CKT. SIZE	DIM. "A"		DIM. "B"		DIM. "D"		PLATING OPTION 5		PLATING OPTION 4		PLATING OPTION 6		
	INCH	MM	INCH	MM	INCH	MM	ITEM NO. TUBE PACKED (WITHOUT CAP)	ITEM NO. TAPE PACKED (WITH CAP)	ITEM NO. TUBE PACKED (WITHOUT CAP)	ITEM NO. TAPE PACKED (WITH CAP)	ITEM NO. TUBE PACKED (WITHOUT CAP)	ITEM NO. TAPE PACKED (WITH CAP)	
04	.079	(2.00)	.165	(4.19)	.183	(4.65)	79109-1001	79109-8401	79109-1051	79109-8451	X	79109-1101	-
06	.157	(4.00)	.244	(6.19)	.183	(4.65)	79109-1002	79109-8402	79109-1052	79109-8452	X	79109-1102	-
08	.236	(6.00)	.322	(8.19)	.183	(4.65)	79109-1003	79109-8403	79109-1053	79109-8453	X	79109-1103	-
10	.315	(8.00)	.401	(10.19)	.183	(4.65)	79109-1004	79109-8404	79109-1054	79109-8454	X	79109-1104	-
12	.394	(10.00)	.480	(12.19)	.183	(4.65)	79109-1005	79109-8405	79109-1055	79109-8455	X	79109-1105	-
14	.472	(12.00)	.559	(14.19)	.183	(4.65)	79109-1006	79109-8406	79109-1056	79109-8456	X	79109-1106	-
16	.551	(14.00)	.637	(16.19)	.183	(4.65)	79109-1007	79109-8407	79109-1057	79109-8457	X	79109-1107	-
18	.630	(16.00)	.716	(18.19)	.183	(4.65)	79109-1008	79109-8408	79109-1058	79109-8458	X	79109-1108	-
20	.709	(18.00)	.795	(20.19)	.183	(4.65)	79109-1009	79109-8409	79109-1059	79109-8459	X	79109-1109	-
22	.787	(20.00)	.874	(22.19)	.183	(4.65)	79109-1010	79109-8410	79109-1060	79109-8460	X	79109-1110	-
24	.866	(22.00)	.952	(24.19)	.183	(4.65)	79109-1011	79109-8411	79109-1061	79109-8461	X	79109-1111	-
26	.945	(24.00)	1.031	(26.19)	.183	(4.65)	79109-1012	79109-8412	79109-1062	79109-8462	X	79109-1112	-
28	1.024	(26.00)	1.110	(28.19)	.183	(4.65)	79109-1013	79109-8413	79109-1063	79109-8463	X	79109-1113	-
30	1.102	(28.00)	1.188	(30.19)	.183	(4.65)	79109-1014	79109-8414	79109-1064	79109-8464	X	79109-1114	-
32	1.181	(30.00)	1.267	(32.19)	.183	(4.65)	79109-1015	79109-8415	79109-1065	79109-8465	X	79109-1115	-
34	1.260	(32.00)	1.346	(34.19)	.183	(4.65)	79109-1016	79109-8416	79109-1066	79109-8466	X	79109-1116	-
36	1.338	(34.00)	1.425	(36.19)	.183	(4.65)	79109-1017	79109-8417	79109-1067	79109-8467	X	79109-1117	-
38	1.417	(36.00)	1.504	(38.19)	.183	(4.65)	79109-1018	79109-8418	79109-1068	79109-8468	X	79109-1118	-
40	1.496	(38.00)	1.582	(40.19)	.183	(4.65)	79109-1019	79109-8419	79109-1069	79109-8469	X	79109-1119	-
42	1.575	(40.00)	1.661	(42.19)	.183	(4.65)	79109-1020	79109-8420	79109-1070	79109-8470	X	79109-1120	-
44	1.654	(42.00)	1.740	(44.19)	.183	(4.65)	79109-1021	79109-8421	79109-1071	79109-8471	X	79109-1121	-
46	1.732	(44.00)	1.818	(46.19)	.183	(4.65)	79109-1022	79109-8422	79109-1072	79109-8472	X	79109-1122	-
48	1.811	(46.00)	1.897	(48.19)	.183	(4.65)	79109-1023	79109-8423	79109-1073	79109-8473	X	79109-1123	-
50	1.890	(48.00)	1.976	(50.19)	.183	(4.65)	79109-1024	79109-8424	79109-1074	79109-8474	X	79109-1124	-

X INDICATES TOOLING NOT AVAILABLE

SPECIAL PACKAGING (TAPE PACKED WITHOUT CAP)

CKT. SIZE	DIM. "A"		DIM. "B"		DIM. "D"		ITEM NO.	PLATING OPTION SEE SHEET 1
	INCH	MM	INCH	MM	INCH	MM		
06	.157	(4.00)	.244	(6.19)	.183	(4.65)	79109-9004	5
20	.709	(18.00)	.795	(20.19)	.183	(4.65)	79109-9005	5
50	1.890	(48.00)	1.976	(50.19)	.183	(4.65)	79109-9006	5
34	1.260	(32.00)	1.346	(34.19)	.183	(4.65)	79109-9007	5

UPDATE REVISION
EC NO: S2005-0714
2005/10/19
DRWN:KSEE
2005/10/19
CHKD:BLW
2005/11/06
APPR:PTLIM

QUALITY SYMBOLS
▽=0
▽C=0

GENERAL TOLERANCES (UNLESS SPECIFIED)

	DIMENSION STYLE	
	mm	INCH
4 PLACES	± .010	± .0004
3 PLACES	± .015	± .0005
2 PLACES	± 0.25	± .010
1 PLACE	± 0.38	± .015

ANGULAR ± 3°

DRAFT WHERE APPLICABLE
MUST REMAIN WITHIN DIMENSIONS

DRAWN BY DATE
AAB 1989/05/15

CHECKED BY DATE
MJM 1989/05/15

APPROVED BY DATE
WAZ 1989/05/15

MATERIAL NO.
SEE TABLE

SCALE NTS
DESIGN UNITS INCH

THIRD ANGLE PROJECTION

SALES DRAWING
2MM DUAL ROW
VERTICAL RECEPTACLE, SMT

MOLEX INCORPORATED

DOCUMENT NO. SDA-79109-***
SHEET NO. 3 OF 9

THIS DRAWING CONTAINS INFORMATION THAT IS PROPRIETARY TO MOLEX INCORPORATED AND SHOULD NOT BE USED WITHOUT WRITTEN PERMISSION

10 9 8 7 6 5 4 3 2 1

PEG OPTION

PLATING OPTION:

- (1) 30µin (0.75µm) MIN. GOLD PLATE IN SELECTED AREA AND 75µin (1.88µm) MIN. TIN/LEAD IN SELECTED AREA OVER 50µin (1.25µm) MIN. NICKEL OVER-ALL.
- (2) 15µin (0.38µm) MIN. GOLD PLATE IN SELECTED AREA AND 75µin (1.88µm) MIN. TIN/LEAD IN SELECTED AREA OVER 50µin (1.25µm) MIN. NICKEL OVER-ALL.
- (3) 5µin (0.13µm) MIN. GOLD PLATE IN SELECTED AREA AND 75µin (1.88µm) MIN. TIN/LEAD IN SELECTED AREA OVER 50µin (1.25µm) MIN. NICKEL OVER-ALL.
- (4) 30µin (0.75µm) MIN. GOLD PLATE IN SELECTED AREA AND 75µin (1.88µm) MIN. TIN IN SELECTED AREA OVER 50µin (1.25µm) MIN. NICKEL OVER-ALL.
- (5) 15µin (0.38µm) MIN. GOLD PLATE IN SELECTED AREA AND 75µin (1.88µm) MIN. TIN IN SELECTED AREA OVER 50µin (1.25µm) MIN. NICKEL OVER-ALL.
- (6) 5µin (0.13µm) MIN. GOLD PLATE IN SELECTED AREA AND 75µin (1.88µm) MIN. TIN IN SELECTED AREA OVER 50µin (1.25µm) MIN. NICKEL OVER-ALL.

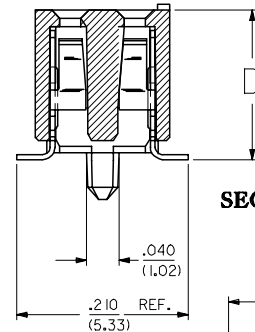
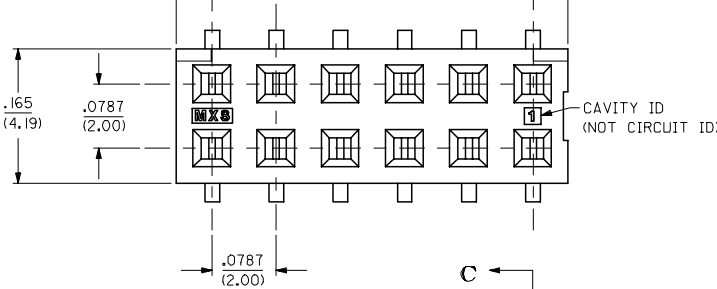
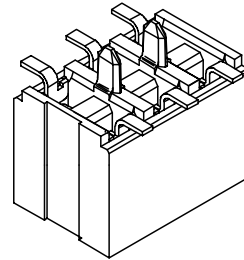

SECTION C-C

Bottom Entry Layout

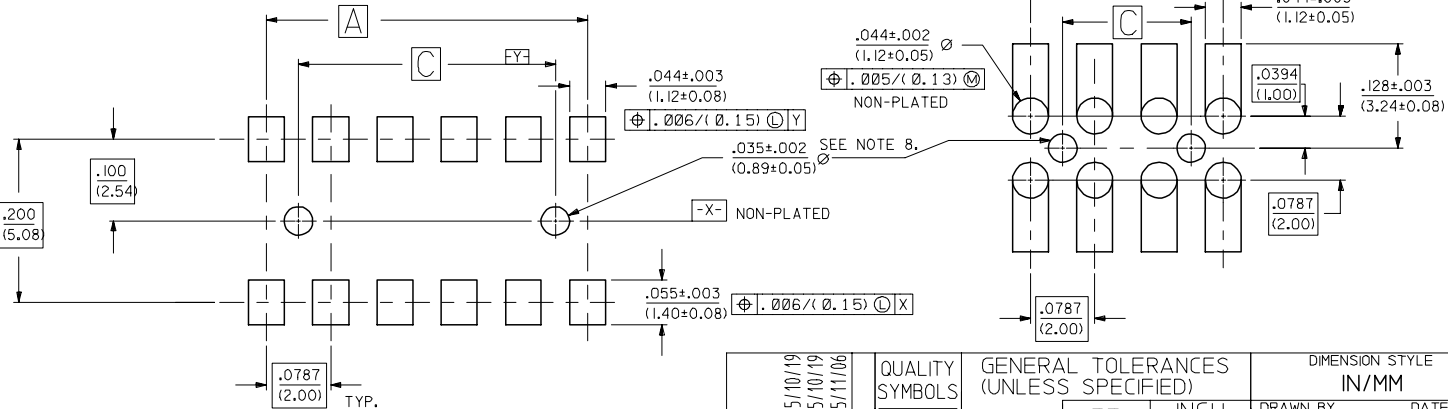

NOTES:

- 1 - HOUSING MATERIAL: GLASS FILLED HIGH TEMP. THERMOPLASTIC. COLOR: BLACK.
- 2 - TERMINAL MATERIAL: PHOSPHOR BRONZE
- 3 - SEE APPROPRIATE SHEET FOR CIRCUIT SIZE, PART NUMBERS AND OVER-ALL DIMENSIONS.
- 4 - FOR ILLUSTRATION, 6&12 CIRCUIT ASSEMBLY SHOWN.
- 5 - REFER TO PRODUCT SPECIFICATION PS-79107. PS-79107 DOES NOT APPLY TO 608 PLATING.
- 6 - TUBE PACKAGING PER PK-70873-0217 OR TAPE PACKAGING PER PK-70873-0259.
- 7 - SEE PSX-79107 FOR SUGGESTED BOTTOM ENTRY PIN LENGTHS.
- 8 - .035 DIA. FOR PRESS FIT ONLY. USE .039±.002 FOR ALIGNMENT PURPOSES ON PICK AND PLACE.

Recommended P.C. Board Layouts

UPDATE REVISION EC NO: S2005-0714 DRWN:KSEE CHKD:BLW APPR:PTLIM 2005/10/19 2005/10/19 2005/11/06	DESCRIPTION REV	QUALITY SYMBOLS ▽=0 ▽=0	GENERAL TOLERANCES (UNLESS SPECIFIED) mm INCH 4 PLACES ± --- ± --- 3 PLACES ± --- ± .010 2 PLACES ± 0.25 ± .015 1 PLACE ± 0.38 ± --- ANGULAR ± 3 °	DIMENSION STYLE IN/MM	SCALE NTS	DESIGN UNITS INCH	THIRD ANGLE PROJECTION
		DRAWN BY RWB	DATE 1991/07/01	TITLE SALES DRAWING 2MM DUAL ROW VERTICAL RECEPTACLE, SMT			
		CHECKED BY JD	DATE 1991/07/01	MOLEX INCORPORATED			
		APPROVED BY WAZ	DATE 1991/07/01	MATERIAL NO. SEE TABLE	DOCUMENT NO. SDA-79109-****	SHEET NO. 4 OF 9	

9 8 7 6 5 4 3 2 1

PEG OPTION (TIN/LEAD)

CKT. SIZE	DIM. "A"		DIM. "B"		DIM. "C"		DIM. "D"		PLATING OPTION 2		PLATING OPTION 1		PLATING OPTION 3	
	INCH	MM	INCH	MM	INCH	MM	INCH	MM	ITEM NO. TUBE PACKED (WITHOUT CAP)	ITEM NO. TAPE PACKED (WITH CAP)	ITEM NO. TUBE PACKED (WITHOUT CAP)	ITEM NO. TAPE PACKED (WITH CAP)	ITEM NO. TUBE PACKED (WITHOUT CAP)	ITEM NO. TAPE PACKED (WITH CAP)
04	.079	(2.00)	.165	(4.19)	-	-	.183	(4.65)	79109-0201	79109-8201	79109-0251	79109-8251	X	79109-0301
06	.157	(4.00)	.244	(6.19)	.079	(2.00)	.183	(4.65)	79109-0202	79109-8202	79109-0252	79109-8252	X	79109-0302
08	.236	(6.00)	.322	(8.19)	.157	(4.00)	.183	(4.65)	79109-0203	79109-8203	79109-0253	79109-8253	X	79109-0303
10	.315	(8.00)	.401	(10.19)	.236	(6.00)	.183	(4.65)	79109-0204	79109-8204	79109-0254	79109-8254	X	79109-0304
12	.394	(10.00)	.480	(12.19)	.315	(8.00)	.183	(4.65)	79109-0205	79109-8205	79109-0255	79109-8255	X	79109-0305
14	.472	(12.00)	.559	(14.19)	.394	(10.00)	.183	(4.65)	79109-0206	79109-8206	79109-0256	79109-8256	X	79109-0306
16	.551	(14.00)	.637	(16.19)	.472	(12.00)	.183	(4.65)	79109-0207	79109-8207	79109-0257	79109-8257	X	79109-0307
18	.630	(16.00)	.716	(18.19)	.551	(14.00)	.183	(4.65)	79109-0208	79109-8208	79109-0258	79109-8258	X	79109-0308
20	.709	(18.00)	.795	(20.19)	.630	(16.00)	.183	(4.65)	79109-0209	79109-8209	79109-0259	79109-8259	X	79109-0309
22	.787	(20.00)	.874	(22.19)	.709	(18.00)	.183	(4.65)	79109-0210	79109-8210	79109-0260	79109-8260	X	79109-0310
24	.866	(22.00)	.952	(24.19)	.787	(20.00)	.183	(4.65)	79109-0211	79109-8211	79109-0261	79109-8261	X	79109-0311
26	.945	(24.00)	1.031	(26.19)	.866	(22.00)	.183	(4.65)	79109-0212	79109-8212	79109-0262	79109-8262	X	79109-0312
28	1.024	(26.00)	1.110	(28.19)	.945	(24.00)	.183	(4.65)	79109-0213	79109-8213	79109-0263	79109-8263	X	79109-0313
30	1.102	(28.00)	1.188	(30.19)	1.024	(26.00)	.183	(4.65)	79109-0214	79109-8214	79109-0264	79109-8264	X	79109-0314
32	1.181	(30.00)	1.267	(32.19)	1.102	(28.00)	.183	(4.65)	79109-0215	79109-8215	79109-0265	79109-8265	X	79109-0315
34	1.260	(32.00)	1.346	(34.19)	1.181	(30.00)	.183	(4.65)	79109-0216	79109-8216	79109-0266	79109-8266	X	79109-0316
36	1.338	(34.00)	1.425	(36.19)	1.260	(32.00)	.183	(4.65)	79109-0217	79109-8217	79109-0267	79109-8267	X	79109-0317
38	1.417	(36.00)	1.504	(38.19)	1.338	(34.00)	.183	(4.65)	79109-0218	79109-8218	79109-0268	79109-8268	X	79109-0318
40	1.496	(38.00)	1.582	(40.19)	1.417	(36.00)	.183	(4.65)	79109-0219	79109-8219	79109-0269	79109-8269	X	79109-0319
42	1.575	(40.00)	1.661	(42.19)	1.496	(38.00)	.183	(4.65)	79109-0220	79109-8220	79109-0270	79109-8270	X	79109-0320
44	1.654	(42.00)	1.740	(44.19)	1.575	(40.00)	.183	(4.65)	79109-0221	79109-8221	79109-0271	79109-8271	X	79109-0321
46	1.732	(44.00)	1.818	(46.19)	1.654	(42.00)	.183	(4.65)	79109-0222	79109-8222	79109-0272	79109-8272	X	79109-0322
48	1.811	(46.00)	1.897	(48.19)	1.732	(44.00)	.183	(4.65)	79109-0223	79109-8223	79109-0273	79109-8273	X	79109-0323
50	1.890	(48.00)	1.976	(50.19)	1.811	(46.00)	.183	(4.65)	79109-0224	79109-8224	79109-0274	79109-8274	X	79109-0324

X INDICATES TOOLING NOT AVAILABLE

SPECIAL PACKAGING (TAPE PACKED WITHOUT CAP)

CKT. SIZE	DIM. "A"		DIM. "B"		DIM. "D"		ITEM NO.	PLATING OPTION SEE SHEET 1
	INCH	MM	INCH	MM	INCH	MM		
50	1.890	(48.00)	1.976	(50.19)	.183	(4.65)	79109-9102	2

UPDATE REVISION
EC NO: S2005-0714
2005/10/19
DRWN:KSEE
CHKD:BLHOW
2005/10/19
APPR:PTLIM
2005/11/06

QUALITY SYMBOLS
▽=0
▽=0

GENERAL TOLERANCES (UNLESS SPECIFIED)

	mm	INCH
4 PLACES	± ---	± ---
3 PLACES	± ---	± .010
2 PLACES	± 0.25	± .015
1 PLACE	± 0.38	± ---
ANGULAR ± 3 °		

DRAFT WHERE APPLICABLE
MUST REMAIN WITHIN DIMENSIONS

DIMENSION STYLE
IN/MM

DRAWN BY DATE
RWB 1991/07/01

CHECKED BY DATE
JD 1991/07/01

APPROVED BY DATE
WAZ 1991/07/01

MATERIAL NO.
SEE TABLE

SCALE
NTS

DESIGN UNITS
INCH

THIRD ANGLE PROJECTION

TITLE
SALES DRAWING
2MM DUAL ROW, WITH PEG
VERTICAL RECEPTACLE, SMT

MOLEX INCORPORATED

DOCUMENT NO.
SDA-79109-***

SHEET NO.
5 OF 9

THIS DRAWING CONTAINS INFORMATION THAT IS PROPRIETARY TO MOLEX INCORPORATED AND SHOULD NOT BE USED WITHOUT WRITTEN PERMISSION

PEG OPTION (TIN)

CKT. SIZE	DIM. "A"		DIM. "B"		DIM. "C"		DIM. "D"		PLATING OPTION 5		PLATING OPTION 4		PLATING OPTION 6	
	INCH	MM	INCH	MM	INCH	MM	INCH	MM	ITEM NO. TUBE PACKED (WITHOUT CAP)	ITEM NO. TAPE PACKED (WITH CAP)	ITEM NO. TUBE PACKED (WITHOUT CAP)	ITEM NO. TAPE PACKED (WITH CAP)	ITEM NO. TUBE PACKED (WITHOUT CAP)	ITEM NO. TAPE PACKED (WITH CAP)
04	.079	(2.00)	.165	(4.19)	-	-	.183	(4.65)	79109-1201	79109-8601	79109-1251	79109-8651	X	79109-1301
06	.157	(4.00)	.244	(6.19)	.079	(2.00)	.183	(4.65)	79109-1202	79109-8602	79109-1252	79109-8652	X	79109-1302
08	.236	(6.00)	.322	(8.19)	.157	(4.00)	.183	(4.65)	79109-1203	79109-8603	79109-1253	79109-8653	X	79109-1303
10	.315	(8.00)	.401	(10.19)	.236	(6.00)	.183	(4.65)	79109-1204	79109-8604	79109-1254	79109-8654	X	79109-1304
12	.394	(10.00)	.480	(12.19)	.315	(8.00)	.183	(4.65)	79109-1205	79109-8605	79109-1255	79109-8655	X	79109-1305
14	.472	(12.00)	.559	(14.19)	.394	(10.00)	.183	(4.65)	79109-1206	79109-8606	79109-1256	79109-8656	X	79109-1306
16	.551	(14.00)	.637	(16.19)	.472	(12.00)	.183	(4.65)	79109-1207	79109-8607	79109-1257	79109-8657	X	79109-1307
18	.630	(16.00)	.716	(18.19)	.551	(14.00)	.183	(4.65)	79109-1208	79109-8608	79109-1258	79109-8658	X	79109-1308
20	.709	(18.00)	.795	(20.19)	.630	(16.00)	.183	(4.65)	79109-1209	79109-8609	79109-1259	79109-8659	X	79109-1309
22	.787	(20.00)	.874	(22.19)	.709	(18.00)	.183	(4.65)	79109-1210	79109-8610	79109-1260	79109-8660	X	79109-1310
24	.866	(22.00)	.952	(24.19)	.787	(20.00)	.183	(4.65)	79109-1211	79109-8611	79109-1261	79109-8661	X	79109-1311
26	.945	(24.00)	1.031	(26.19)	.866	(22.00)	.183	(4.65)	79109-1212	79109-8612	79109-1262	79109-8662	X	79109-1312
28	1.024	(26.00)	1.110	(28.19)	.945	(24.00)	.183	(4.65)	79109-1213	79109-8613	79109-1263	79109-8663	X	79109-1313
30	1.102	(28.00)	1.188	(30.19)	1.024	(26.00)	.183	(4.65)	79109-1214	79109-8614	79109-1264	79109-8664	X	79109-1314
32	1.181	(30.00)	1.267	(32.19)	1.102	(28.00)	.183	(4.65)	79109-1215	79109-8615	79109-1265	79109-8665	X	79109-1315
34	1.260	(32.00)	1.346	(34.19)	1.181	(30.00)	.183	(4.65)	79109-1216	79109-8616	79109-1266	79109-8666	X	79109-1316
36	1.338	(34.00)	1.425	(36.19)	1.260	(32.00)	.183	(4.65)	79109-1217	79109-8617	79109-1267	79109-8667	X	79109-1317
38	1.417	(36.00)	1.504	(38.19)	1.338	(34.00)	.183	(4.65)	79109-1218	79109-8618	79109-1268	79109-8668	X	79109-1318
40	1.496	(38.00)	1.582	(40.19)	1.417	(36.00)	.183	(4.65)	79109-1219	79109-8619	79109-1269	79109-8669	X	79109-1319
42	1.575	(40.00)	1.661	(42.19)	1.496	(38.00)	.183	(4.65)	79109-1220	79109-8620	79109-1270	79109-8670	X	79109-1320
44	1.654	(42.00)	1.740	(44.19)	1.575	(40.00)	.183	(4.65)	79109-1221	79109-8621	79109-1271	79109-8671	X	79109-1321
46	1.732	(44.00)	1.818	(46.19)	1.654	(42.00)	.183	(4.65)	79109-1222	79109-8622	79109-1272	79109-8672	X	79109-1322
48	1.811	(46.00)	1.897	(48.19)	1.732	(44.00)	.183	(4.65)	79109-1223	79109-8623	79109-1273	79109-8673	X	79109-1323
50	1.890	(48.00)	1.976	(50.19)	1.811	(46.00)	.183	(4.65)	79109-1224	79109-8624	79109-1274	79109-8674	X	79109-1324

X INDICATES TOOLING NOT AVAILABLE

SPECIAL PACKAGING (TAPE PACKED WITHOUT CAP)

CKT. SIZE	DIM. "A"		DIM. "B"		DIM. "D"		ITEM NO.	PLATING OPTION SEE SHEET 1
	INCH	MM	INCH	MM	INCH	MM		
50	1.890	(48.00)	1.976	(50.19)	.183	(4.65)	79109-9103	5

UPDATE REVISION
EC NO: S2005-0714
2005/10/19
DRWN:KSEE
CHKD:BLHOW
2005/10/19
APPR:PTLIM
2005/11/07

QUALITY SYMBOLS
▽=0
▽=0

GENERAL TOLERANCES (UNLESS SPECIFIED)

	mm	INCH
4 PLACES	± ---	± ---
3 PLACES	± ---	± .010
2 PLACES	± 0.25	± .015
1 PLACE	± 0.38	± ---
ANGULAR ± 3 °		

DRAFT WHERE APPLICABLE
MUST REMAIN WITHIN DIMENSIONS

DIMENSION STYLE
IN/MM

DRAWN BY: RWB DATE: 1991/07/01
CHECKED BY: JD DATE: 1991/07/01
APPROVED BY: WAZ DATE: 1991/07/01

MATERIAL NO. SEE TABLE

SCALE: NTS
DESIGN UNITS: INCH
THIRD ANGLE PROJECTION

SALES DRAWING
2MM DUAL ROW
VERTICAL RECEPTACLE, SMT

MOLEX INCORPORATED

DOCUMENT NO. SDA-79109-****
SHEET NO. 6 OF 9

THIS DRAWING CONTAINS INFORMATION THAT IS PROPRIETARY TO MOLEX INCORPORATED AND SHOULD NOT BE USED WITHOUT WRITTEN PERMISSION

SPECIAL - PEG OPTION WITH CUSTOM TERMINAL FEET (TIN/LEAD)

CKT. SIZE	DIM. "A"		DIM. "B"		DIM. "C"		DIM. "D"		PLATING OPTION 2		PLATING OPTION 2		PLATE					
	INCH	MM	INCH	MM	INCH	MM	INCH	MM	ITEM NO. TUBE PACKED (WITHOUT CAP)	ITEM NO. TAPE PACKED (WITH CAP)	ITEM NO. TUBE PACKED (WITHOUT CAP)	ITEM NO. TAPE PACKED (WITH CAP)	ITEM NO. TUBE PACKED (WITHOUT CAP)	ITEM NO. TAPE PACKED (WITH CAP)	ITEM NO. TUBE PACKED (WITHOUT CAP)	ITEM NO. TAPE PACKED (WITH CAP)		
	04	.079	(2.00)	.165	(4.19)	-	-	.185	(4.70)	X		X	79109-8351	X		X		X
06	.157	(4.00)	.244	(6.19)	.079	(2.00)	.185	(4.70)	X		X	79109-8352	X		X		X	
08	.236	(6.00)	.322	(8.19)	.157	(4.00)	.185	(4.70)	X		X	79109-8353	X		X		X	
10	.315	(8.00)	.401	(10.19)	.236	(6.00)	.185	(4.70)	X		X	79109-8354	X		X		X	
12	.394	(10.00)	.480	(12.19)	.315	(8.00)	.185	(4.70)	X		X	79109-8355	X		X		X	
14	.472	(12.00)	.559	(14.19)	.394	(10.00)	.185	(4.70)	X		X	79109-8356	X		X		X	
16	.551	(14.00)	.637	(16.19)	.472	(12.00)	.185	(4.70)	X		X	79109-8357	X		X		X	
18	.630	(16.00)	.716	(18.19)	.551	(14.00)	.185	(4.70)	X		X	79109-8358	X		X		X	
20	.709	(18.00)	.795	(20.19)	.630	(16.00)	.185	(4.70)	X		X	79109-8359	X		X		X	
22	.787	(20.00)	.874	(22.19)	.709	(18.00)	.185	(4.70)	X		X	79109-8360	X		X		X	
24	.866	(22.00)	.952	(24.19)	.787	(20.00)	.185	(4.70)	X		X	79109-8361	X		X		X	
26	.945	(24.00)	1.031	(26.19)	.866	(22.00)	.185	(4.70)	X		X	79109-8362	X		X		X	
28	1.024	(26.00)	1.110	(28.19)	.945	(24.00)	.185	(4.70)	X		X	79109-8363	X		X		X	
30	1.102	(28.00)	1.188	(30.19)	1.024	(26.00)	.185	(4.70)		79109-7000		79109-8364	X			79109-7064	X	
32	1.181	(30.00)	1.267	(32.19)	1.102	(28.00)	.185	(4.70)	X		X	79109-8365	X		X		X	
34	1.260	(32.00)	1.346	(34.19)	1.181	(30.00)	.185	(4.70)	X		X	79109-8366	X		X		X	
36	1.338	(34.00)	1.425	(36.19)	1.260	(32.00)	.185	(4.70)	X		X	79109-8367	X		X		X	
38	1.417	(36.00)	1.504	(38.19)	1.338	(34.00)	.185	(4.70)	X		X	79109-8368	X		X		X	
40	1.496	(38.00)	1.582	(40.19)	1.417	(36.00)	.185	(4.70)	X		X	79109-8369	X		X		X	
42	1.575	(40.00)	1.661	(42.19)	1.496	(38.00)	.185	(4.70)	X		X	N.A.	X		X		X	N.A.
44	1.654	(42.00)	1.740	(44.19)	1.575	(40.00)	.185	(4.70)		79109-7006	X	N.A.	X		X		X	N.A.
46	1.732	(44.00)	1.818	(46.19)	1.654	(42.00)	.185	(4.70)	X		X	N.A.	X		X		X	N.A.
48	1.811	(46.00)	1.897	(48.19)	1.732	(44.00)	.185	(4.70)	X		X	N.A.	X		X		X	N.A.
50	1.890	(48.00)	1.976	(50.19)	1.811	(46.00)	.185	(4.70)		79109-7005	X	N.A.	X		X		X	N.A.

*X INDICATES TOOLING NOT AVAILABLE

SPECIAL - PEG OPTION WITH CUSTOM T.F & VOIDED CIRCUITS (TIN/LEAD)

CKT. SIZE	ASSEMBLY		VOID LOCATION(S) SEE SHEET 1 FOR CONVENTION		PLATING OPTION	DIM. "A"		DIM. "B"		DIM. "C"		DIM. "D"	
	ITEM NO. TUBE PACKED (WITHOUT CAP)	ITEM NO. TAPE PACKED (WITH CAP)	ROW	CKT. NO.(S)		INCH	MM	INCH	MM	INCH	MM	INCH	MM
	48	79109-7001	X 79109-8381	ROW A		1, 24	2	1.811	(46.00)	1.897	(48.19)	1.732	(44.00)
42	79109-7002	X 79109-8382	ROW A	1, 21	2	1.575	(40.00)	1.661	(42.19)	1.496	(38.00)	.185	(4.70)
20	79109-7003	79109-8383	ROW A	1, 10	2	.709	(18.00)	.795	(20.19)	.630	(16.00)	.185	(4.70)
50	79109-7004	X 79109-8384	ROW B	13	2	1.890	(48.00)	1.976	(50.19)	1.811	(46.00)	.185	(4.70)

UPDATE REVISION EC NO: S2005-0714 DRWN:KSEE CHKD:BLHOW APPR:PTLIM 2005/10/19 2005/10/19 2005/11/07	QUALITY SYMBOLS ▽=0 ▽=0	GENERAL TOLERANCES (UNLESS SPECIFIED)		DIMENSION STYLE IN/MM		SCALE NTS	DESIGN UNITS INCH	THIRD ANGLE PROJECTION		
		4 PLACES ± --- ± --- 3 PLACES ± --- ± .010 2 PLACES ± 0.25 ± .015 1 PLACE ± 0.38 ± --- ANGULAR ± 3 °		DRAWN BY DATE RWB 1991/07/18		TITLE SALES DRAWING 2MM DUAL ROW VERTICAL RECEPTACLE, SMT		MOLEX INCORPORATED		
		DRAFT WHERE APPLICABLE MUST REMAIN WITHIN DIMENSIONS		APPROVED BY DATE WAZ 1991/07/18		MATERIAL NO.		DOCUMENT NO. SDA-79109-***		SHEET NO. 7 OF 9
		SEE TABLE		THIS DRAWING CONTAINS INFORMATION THAT IS PROPRIETARY TO MOLEX INCORPORATED AND SHOULD NOT BE USED WITHOUT WRITTEN PERMISSION						

SPECIAL - PEG OPTION WITH CUSTOM TERMINAL FEET (TIN)

CKT. SIZE	DIM. "A"		DIM. "B"		DIM. "C"		DIM. "D"		PLATING OPTION 5		PLATING OPTION 5		PLATE			
	INCH	MM	INCH	MM	INCH	MM	INCH	MM	ITEM NO. TUBE PACKED (WITHOUT CAP)	ITEM NO. TAPE PACKED (WITH CAP)	ITEM NO. TUBE PACKED (WITHOUT CAP)	ITEM NO. TAPE PACKED (WITH CAP)	ITEM NO. TUBE PACKED (WITHOUT CAP)	ITEM NO. TAPE PACKED (WITH CAP)		
04	.079	(2.00)	.165	(4.19)	-	-	.185	(4.70)	X		X	79109-8751	X		X	
06	.157	(4.00)	.244	(6.19)	.079	(2.00)	.185	(4.70)	X		X	79109-8752	X		X	
08	.236	(6.00)	.322	(8.19)	.157	(4.00)	.185	(4.70)	X		X	79109-8753	X		X	
10	.315	(8.00)	.401	(10.19)	.236	(6.00)	.185	(4.70)	X		X	79109-8754	X		X	
12	.394	(10.00)	.480	(12.19)	.315	(8.00)	.185	(4.70)	X		X	79109-8755	X		X	
14	.472	(12.00)	.559	(14.19)	.394	(10.00)	.185	(4.70)	X		X	79109-8756	X		X	
16	.551	(14.00)	.637	(16.19)	.472	(12.00)	.185	(4.70)	X		X	79109-8757	X		X	
18	.630	(16.00)	.716	(18.19)	.551	(14.00)	.185	(4.70)	X		X	79109-8758	X		X	
20	.709	(18.00)	.795	(20.19)	.630	(16.00)	.185	(4.70)	X		X	79109-8759	X		X	
22	.787	(20.00)	.874	(22.19)	.709	(18.00)	.185	(4.70)	X		X	79109-8760	X		X	
24	.866	(22.00)	.952	(24.19)	.787	(20.00)	.185	(4.70)	X		X	79109-8761	X		X	
26	.945	(24.00)	1.031	(26.19)	.866	(22.00)	.185	(4.70)	X		X	79109-8762	X		X	
28	1.024	(26.00)	1.110	(28.19)	.945	(24.00)	.185	(4.70)	X		X	79109-8763	X		X	
30	1.102	(28.00)	1.188	(30.19)	1.024	(26.00)	.185	(4.70)		79109-7010		79109-8764	X			79109-7065
32	1.181	(30.00)	1.267	(32.19)	1.102	(28.00)	.185	(4.70)	X		X	79109-8765	X		X	
34	1.260	(32.00)	1.346	(34.19)	1.181	(30.00)	.185	(4.70)	X		X	79109-8766	X		X	
36	1.338	(34.00)	1.425	(36.19)	1.260	(32.00)	.185	(4.70)	X		X	79109-8767	X		X	
38	1.417	(36.00)	1.504	(38.19)	1.338	(34.00)	.185	(4.70)	X		X	79109-8768	X		X	
40	1.496	(38.00)	1.582	(40.19)	1.417	(36.00)	.185	(4.70)	X		X	79109-8769	X		X	
42	1.575	(40.00)	1.661	(42.19)	1.496	(38.00)	.185	(4.70)	X		X	N.A.	X		X	N.A.
44	1.654	(42.00)	1.740	(44.19)	1.575	(40.00)	.185	(4.70)		79109-7016	X	N.A.	X		X	N.A.
46	1.732	(44.00)	1.818	(46.19)	1.654	(42.00)	.185	(4.70)	X		X	N.A.	X		X	N.A.
48	1.811	(46.00)	1.897	(48.19)	1.732	(44.00)	.185	(4.70)	X		X	N.A.	X		X	N.A.
50	1.890	(48.00)	1.976	(50.19)	1.811	(46.00)	.185	(4.70)		79109-7015	X	N.A.	X		X	N.A.

*X INDICATES TOOLING NOT AVAILABLE

SPECIAL - PEG OPTION WITH CUSTOM T.F & VOIDED CIRCUITS (TIN)

CKT. SIZE	ASSEMBLY		VOID LOCATION(S) SEE SHEET 1 FOR CONVENTION		PLATING OPTION	DIM. "A"		DIM. "B"		DIM. "C"		DIM. "D"	
	ITEM NO. TUBE PACKED (WITHOUT CAP)	ITEM NO. TAPE PACKED (WITH CAP)	ROW	CKT. NO.(S)		INCH	MM	INCH	MM	INCH	MM	INCH	MM
48	79109-7011	X 79109-8385	ROW A	1, 24	5	1.811	(46.00)	1.897	(48.19)	1.732	(44.00)	.185	(4.70)
42	79109-7012	X 79109-8386	ROW A	1, 21	5	1.575	(40.00)	1.661	(42.19)	1.496	(38.00)	.185	(4.70)
20	79109-7013	79109-8387	ROW A	1, 10	5	.709	(18.00)	.795	(20.19)	.630	(16.00)	.185	(4.70)
50	79109-7014	X 79109-8388	ROW B	13	5	1.890	(48.00)	1.976	(50.19)	1.811	(46.00)	.185	(4.70)

UPDATE REVISION EC NO: S2005-0714 DRWN:KSEE CHKD:BLHOW APPR:PTLIM 2005/10/19 2005/10/19 2005/11/07	QUALITY SYMBOLS ▽=0 ▽=0	GENERAL TOLERANCES (UNLESS SPECIFIED)		DIMENSION STYLE IN/MM		SCALE NTS	DESIGN UNITS INCH	THIRD ANGLE PROJECTION		
		4 PLACES ± --- ± --- 3 PLACES ± --- ± .010 2 PLACES ± 0.25 ± .015 1 PLACE ± 0.38 ± --- ANGULAR ± 3 °		DRAWN BY RWB		DATE 1991/07/18	TITLE SALES DRAWING 2MM DUAL ROW VERTICAL RECEPTACLE, SMT			
		DRAFT WHERE APPLICABLE MUST REMAIN WITHIN DIMENSIONS		APPROVED BY WAZ		DATE 1991/07/18	MOLEX INCORPORATED			
		SEE TABLE		MATERIAL NO.		DOCUMENT NO. SDA-79109-***x	SHEET NO. 8 OF 9			

VOIDED CIRCUIT OPTION

ASSEMBLIES WITHOUT PEGS

CKT. SIZE	ASSEMBLY (WITHOUT CAP IN TUBE)		VOID LOCATION(S) SEE SHEET 1 FOR CONVENTION		PLATING OPTION	DIM. "A"		DIM. "B"		DIM. "D"		PLATING OPTION
	ITEM NO.	ENG. NO.	ROW	CKT. NO.(S)		INCH	MM	INCH	MM	INCH	MM	
22	79109-5001	79109-5001	ROW A	2	1	.787	(20.00)	.874	(22.19)	.183	(4.65)	TIN/LEAD
6	79109-5002	79109-5002	ROW A	2	2	.157	(4.00)	.244	(6.19)	.183	(4.65)	
22	79109-5011	79109-5011	ROW A	2	4	.787	(20.00)	.874	(22.19)	.183	(4.65)	TIN
6	79109-5012	79109-5012	ROW A	2	5	.157	(4.00)	.244	(6.19)	.183	(4.65)	

ASSEMBLIES WITH PEGS

CKT. SIZE	ASSEMBLY (WITHOUT CAP IN TUBE)		VOID LOCATION(S) SEE SHEET 1 FOR CONVENTION		PLATING OPTION	DIM. "A"		DIM. "B"		DIM. "C"		DIM. "D"		PLATING OPTION
	ITEM NO.	ENG. NO.	ROW	CKT. NO.(S)		INCH	MM	INCH	MM	INCH	MM	INCH	MM	
48	79109-6001	79109-6001	ROW A	1, 24	2	1.811	(46.00)	1.897	(48.19)	1.732	(44.00)	.183	(4.65)	TIN/LEAD
44	79109-6002	79109-6002	ROW B	10	2	1.654	(42.00)	1.740	(44.19)	1.575	(42.00)	.183	(4.65)	
48	79109-6011	79109-6011	ROW A	1, 24	5	1.811	(46.00)	1.897	(48.19)	1.732	(44.00)	.183	(4.65)	TIN
44	79109-6012	79109-6012	ROW B	10	5	1.654	(42.00)	1.740	(44.19)	1.575	(42.00)	.183	(4.65)	

NOTES:

1. TERMINALS WILL BE PRESENT IN VOIDED LOCATIONS HOWEVER, PIN WINDOWS WILL BE CLOSED.
2. VOIDS CAN ONLY BE PRESENT IN ONE ROW OF A CONNECTOR.

UPDATE REVISION EC NO: S2005-0714 DRWN:SEE CHKD:BLW APPR:PTLIM 2005/10/19 2005/10/19 2005/11/08	QUALITY SYMBOLS ▽=0 ◻=0	GENERAL TOLERANCES (UNLESS SPECIFIED)		DIMENSION STYLE IN/MM		SCALE NTS	DESIGN UNITS INCH	THIRD ANGLE PROJECTION			
						DRAWN BY DATE		SALES DRAWING 2MM DUAL ROW VERTICAL RECEPTACLE, SMT MOLEX INCORPORATED			
						RWB 1991/07/18					
						CHECKED BY DATE					
				2 PLACES ±0.25 ±.015		JD 1991/07/18					
				1 PLACE ±0.38 ±---		APPROVED BY DATE					
				ANGULAR ± 3 °		WAZ 1991/07/18					
				DRAFT WHERE APPLICABLE MUST REMAIN WITHIN DIMENSIONS		MATERIAL NO.		DOCUMENT NO.		SHEET NO.	
						SEE TABLE		SDA-79109-****		9 OF 9	
						SIZE A3		THIS DRAWING CONTAINS INFORMATION THAT IS PROPRIETARY TO MOLEX INCORPORATED AND SHOULD NOT BE USED WITHOUT WRITTEN PERMISSION			